

CENTRAL MATERIAL HANDLING

Conveying and Drying
for Plastics Processing Plants

world of innovation



Feedmax B

Central material loaders

The **Feedmax B** series loaders are built for highest functionality and demanding applications. The modular design of these vacuum loaders guarantees specific adjustment to meet individual customer requirements, as well as for simple cleaning.

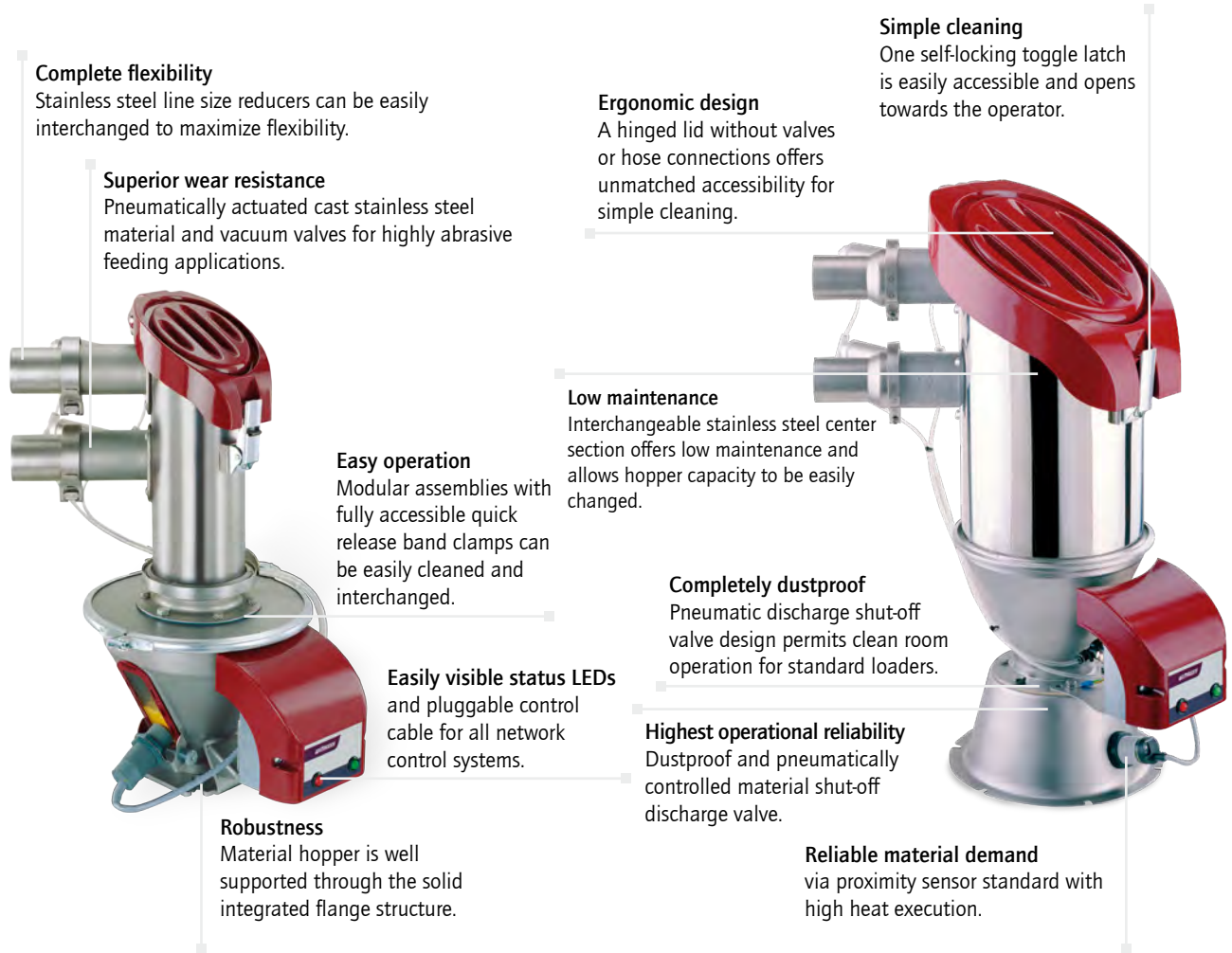

Complete flexibility
Stainless steel line size reducers can be easily interchanged to maximize flexibility.

Superior wear resistance
Pneumatically actuated cast stainless steel material and vacuum valves for highly abrasive feeding applications.

Ergonomic design
A hinged lid without valves or hose connections offers unmatched accessibility for simple cleaning.

Simple cleaning
One self-locking toggle latch is easily accessible and opens towards the operator.

Easy operation
Modular assemblies with fully accessible quick release band clamps can be easily cleaned and interchanged.

Low maintenance
Interchangeable stainless steel center section offers low maintenance and allows hopper capacity to be easily changed.

Robustness
Material hopper is well supported through the solid integrated flange structure.

Completely dustproof
Pneumatic discharge shut-off valve design permits clean room operation for standard loaders.

Easily visible status LEDs and pluggable control cable for all network control systems.

Highest operational reliability
Dustproof and pneumatically controlled material shut-off discharge valve.

Reliable material demand
via proximity sensor standard with high heat execution.

Advantages of Feedmax B series loaders



The **Feedmax CT (clear tube)** series permits from any viewing angle simple visual flow of the material. The high-quality glass section is balanced for high loads and an optimal material flow.



Slanted lid and center body valves are completely accessible for easier and simpler cleaning access than conventional design.



Pneumatic material discharge shut off valve
Highest functionality guaranteed through a completely leak-proof seal every conveying cycle. The dustproof design also guarantees dust free operation at the machine hopper.

GM blower stations and central conveying

Wittmann

Blower/ pump model	Pump type	GM central conveying	Power [kW]	max. Airflow [m ³ @50Hz] [cfm@50Hz]	max. Pressure [mbar@50Hz] [in.Hg@50Hz]
03	Side channel blower single stage	•	1.5	210 (123)	200 (5.9)
05	Side channel blower single stage	•	2.2	305	230
07	Side channel blower 2-stage	•	3	210 (123)	340 (10.0)
09	Side channel blower 2-stage	•	4.3	310 (182)	360 (10.6)
13	Side channel blower 2-stage	•	7.5	500 (294)	400 (11.8)
29	Claw pump	•	4.2	200 (117)	700 (20.6)
31	Claw pump	•	5	250 (147)	700 (20.6)
33	Claw pump	•	6	300 (176)	700 (20.6)



GM central filter stations

CS cyclone filter station

» 2-stage filtration system

In first stage pre-filtration takes place by means of the cyclone effect and in the second stage, micro filtration occurs by means of a polyester micro filter.

» Effective dust blow-off and user-friendliness

The filter surface is cleaned by means of implosion, and the dust is blown into a dust collection bag. For visual inspection, the dust container is executed in robust glass.

XMB filter station

» 2-stage filtration system

In first stage pre-filtration takes place by means of the cyclone effect and in the second stage, micro filtration occurs with a polyester micro-filter having 3 m² of surface area.

» User-friendly

The dust container can be removed during operation for emptying.

» Choice of dust container

The dust collection area is kept pressureless through a shut-off valve in the discharge cone of the filter and therefore allows the use of any dust collection container, e.g. a plastic bag.



XMB
filter station



Machine
hopper

Machine hopper for Feedmax

Machine hoppers ranging in size from 3 l to 60 l guarantee the optimum volume of the material inventory to the total material throughput and thus, the performance of the entire system.

» Stainless steel construction with sight glass

Sight glass for abrasive uses as well as visual control of the material flow.

» Assembly

Slotted holes in the flange allow easy attachment for various mounting hole patterns.

M8

Network control system

The **M8** network control system was developed for the administration of medium to complex network configurations with up to 320 network participants. Every participant is connected via a bus module to the network and can be configured for a specific task. This guarantees the maximum flexibility for the set up of customized material handling systems.

» **M8 touch-screen**

The high-resolution touch-screen simplifies user control, as well as the adjustment of process parameters and allows the user a comprehensive view of all attached units.

» **Line server LS-B30T**

Provides for the control of up to 31 freely configurable bus modules, which can be connected in parallel to one CAN-Bus line. All functions which are available for the respective bus modules can be managed and controlled from the line server. A complete system can have up to 8 individual CAN-Bus lines.

» **Bus module BM-8/8**

Provides individual control of vacuum loaders, blower stations, central filters, dry air valves, purging valves, etc. Any function can be assigned to the 4 digital inputs and outputs of the bus modules and therefore, gives the system virtually unlimited possibilities of configurability for each particular application.



M8 15" XGA touch-screen

Line server LS-B30 T



Bus module BM-8/8

M8 functional scheme

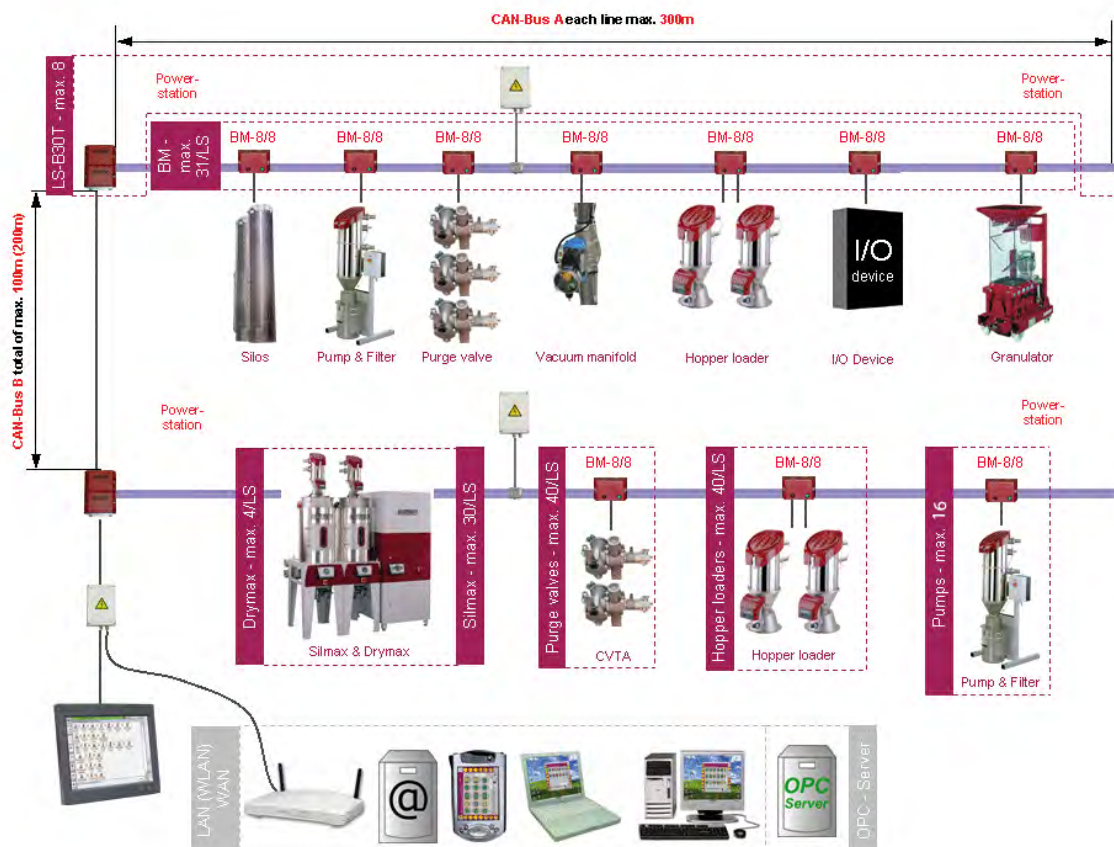

M8 – Software features



Material based representation

Visualization of the conveying system using lines to represent the respective material flow of the entire system.

- » **Clear representation**
The partially complex single material flow is displayed with a few symbols.
- » **Simple changeover**
Switch to vacuum line representation or other displays.



Vacuum loader display

- » **Adjustment of the loading time**
Adjustment can be made at any time in the edit mode.
- » **Conveying sequence**
In the presence of a purging valve adjustment of the optimum loading sequence.

M8 – Networked drying systems

The M8 control system permits the connection of Drymax battery dryers with network cards to the central M8 control system. This allows the visualization of internal parameters and conditions on the generously dimensioned M8 control screen as well as the entry of temperature values for the various connected drying hoppers.

- » **Connection**
of up to 32 battery dryers with 240 drying hoppers.
- » **Optimized control**
Manages internal process of the dryer with failure analysis.
- » **Dew point recording**
In the presence of a dew point sensor the actual values are captured and recorded over a 12 hour time period.
- » **Management of material data**
Includes all drying hoppers attached to the networked dryer.
- » **Central error display**
All error messages are transferred to the M8 control and centrally displayed.



Drymax specifications



Silmax specifications

M8 – Software features



Barcode screen



M8 – Coded material source licence and batch administration

Choosing the wrong material for a drying hopper in the course of a material change procedure is not only leading to weak drying results, but can also have fatal consequences for the production of parts. To minimize this risk, and after having activated a licence, the M8 network control can monitor this process. For the clearance of the conveying process, the operator has to define the material change at the control device, and afterwards to confirm the material source and the suction lance via barcode scan. If this is done correctly, the charging process starts. If not, an error message is displayed, and the charging process (with the wrong material) is not executed. This function can even be extended applying the WiMaTRACE batch monitoring function.

Codemax – RFID coupling station

The coded Coupling Station Codemax avoids the erroneous connection of the wrong material to the processing machine.

» RFID coding

A transponder, working on the basis of "Radio Frequency Identification" (RFID), permits remote recognition of a 64-bit identifier. By means of this technology, electrostatic charges which are inherent to the material conveying process cannot cause damage to the electrical components.

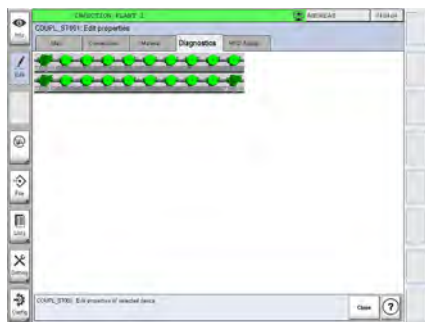

M8 Coupling station – Visualization



Codemax – RFID coupling station

M8 – Connection to ERP systems

All relevant control data and parameters can be transferred to a company wide enterprise resource planning (ERP) and process data monitoring (PDM) system via the open standard protocol OPC.

For the connection to a PDM system the M8 control system is optionally equipped with an OPC Interface Licence, which enables the communication between an external computer and the control system. A customer supplied OPC client accepts the required data from the M8 control system and manipulates it internally. The data exchange happens via the Ethernet interface.



Drymax 180 – 1200

Battery dryers

Wittmann

The **Drymax** battery dryer series are equipped with two desiccant beds and therefore provide continuous process air and constant dry air quality for the perfect drying of plastic resin.

- » **Dew Point up to -60°C (-76°F)**
- » **Weekly timer**
- » **Switchover valves, stop position controlled**
The switchover valves provide optimized control of drying and regeneration cycles in both desiccant beds.
- » **Energy saving regeneration**
Reduces energy costs through fastest dehumidification of the desiccant beds during the regeneration phase.
- » **SmartReg energy saving function**
Time-optimized control of the regeneration and cooling of the desiccant beds.
- » **Micro particle filter in return air**
Dust separation efficiency of up to 99.9% for high process safety.
- » **Side channel blowers**
For separate process and regeneration blowers in order to guarantee constant air flow even during fluctuating pressure conditions.

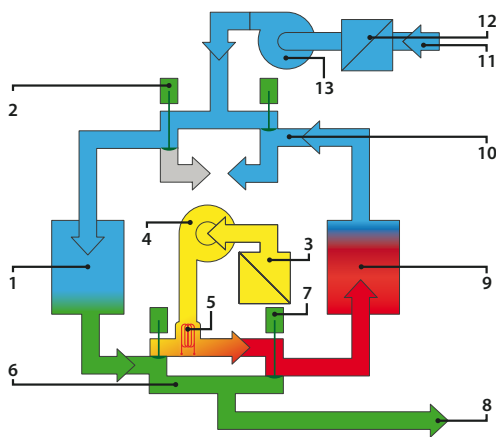

- | | |
|-----------------------------|-------------------------------------|
| 1 Desiccant bed(in Process) | 8 Process air |
| 2 Switchover valve 1 | 9 Desiccant bed 2 (in regeneration) |
| 3 Inlet filter | 10 Switchover valve 2 |
| 4 Regeneration blower | 11 Return air |
| 5 Regeneration heater | 12 Microfilter |
| 6 Switchover valve 3 | 13 Process blower |
| 7 Switchover valve 4 | |

Options

- » **Dew point sensor**
For dew point desiccant bed changes – visualization with alarm function.
- » **Return air cooler**
- » **Micro particle filter for process air**
- » **Frequency-controlled process blower**
- » **Redundant dryer control**
- » **Automatic activation/deactivation of dry air generator**
Optimization of the overall performance of the drying system.



Aton 1000

Battery dryer

The **Aton 1000** battery wheel dryer is equipped with a clocked rotating segmented wheel, thus allowing for a constant creation of dry air. The highly developed drying wheel named **ECO wheel** is isolated and consists of several segments that are closely filled with a highly efficient desiccant, thus allowing operation at a constantly low dew point.

- » **Intelligent CrossFlow function**
Heat exchanger with closed circuit leading to a reduction of energy consumption.
- » **Isolated ECO wheel drying wheel**
Allows to operate the dry air dryer at a low dew point of up to -65°C (-85°F).
- » **Chain drive with automatic tensioning device**
For less maintenance and reliable operation.
- » **5,7" Touch-screen user interface**
For an easy input of the dryer settings.
- » **AmbiLED performance indication**
Not only the operation mode of the dryer is displayed, but also its actual performance.
- » **User-friendly access for maintenance**
Return air filter and regeneration filter are accessible from the outside.

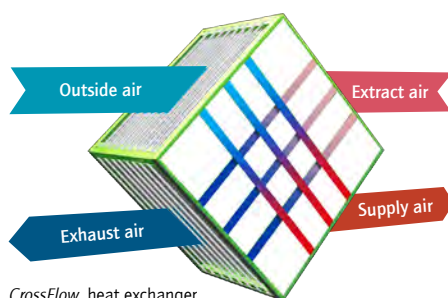

CrossFlow, heat exchanger with an efficiency of 80–90%, schematic representation

Options

- » **Dew point sensor**
For a dew point controlled drying process - visualization with alarm function.
- » **Return air cooler**
- » **Micro particle filter for process air**
- » **Frequency-controlled process blower**
- » **Redundant dryer control**
- » **Automatic activation/deactivation of dry air generator**
Optimization of the overall performance of the drying system.



Silmax 100 – 1200

Drying hoppers

wittmann

The **Silmax** drying hoppers with integrated microprocessor control are available in table versions from 100 up to 1,200 l.

- » **Robust stainless steel execution**
All components in contact with the material are made of stainless steel and are therefore perfectly suited for critical and abrasive applications.
- » **Efficiency enhancing insulation**
The drying hoppers are equipped with 40 mm thick insulation across the entire height in order to reduce heat losses and increase drying efficiency.
- » **SmartFlow intelligent air distribution**
Automatic air distribution to adjust to different materials and fluctuating material demands.
- » **Integrated CAN interface**
Allows extensive data exchange and status forwarding between the dryer and a central system for visualization.
- » **Convenient clean out door**
Drying hoppers of sizes 100 l and up are equipped as standard with a clean-out door ideally suited for the respective hopper diameter. The perfect geometry of the hopper guarantees uniform drying of the material across the entire cross section.
- » **Integrated sight glass**
For the convenient visual inspection of material flow and material level.
- » **Material slide gate**
All drying hoppers are included as a standard with a manual slide gate.
- » **Material saver function**
Avoids over-drying and thermal degradation of the plastic resin through short term lowering of the drying temperature during production stoppages of the processing machine.

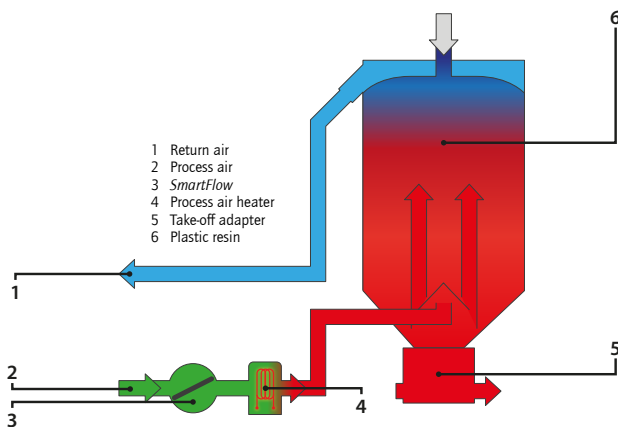

Options

Vacuum take-off adapter

Available with one or two material outlets as well as with controlled discharged valve for the efficient purging after the loading cycle (in connection with WITTMANN M8/Net5 control system).

Drymax/Aton/Silmax application table

Material	Drying time [h]	Temp. [°C]	Bulk density [kg/dm³]	Drymax [kg/h]						Aton 1000 [kg/h]	Silmax [kg/h]										
				180	300	450	600	900	1200		30	50	100	150	200	300	400	600	800	1,000	1,200
ABS	2.5	80	0.63	111	185	278	370	556	741	617	8	13	25	38	50	76	101	151	202	252	304
ASA	3	80	0.66	111	185	278	370	556	741	617	7	11	22	33	44	66	88	132	176	220	264
CA	2.8	65	0.78	73	122	183	244	366	488	407	9	16	31	47	62	94	125	187	250	312	376
CP	2.5	70	0.74	78	130	195	260	390	519	433	9	15	30	44	59	89	118	178	237	296	356
EVA	2	80	0.57	63	105	157	210	315	420	350	9	14	29	43	57	86	114	171	228	285	344
IONOMERE	3.5	90	0.56	69	116	174	232	347	463	386	5	8	16	24	32	48	64	96	128	160	192
PA 11	3	75	0.62	110	184	276	368	552	736	613	6	10	21	31	41	62	83	124	165	207	248
PA 12	3	75	0.62	87	145	217	290	435	580	483	6	10	21	31	41	62	83	124	165	207	248
PA6	3	80	0.68	85	142	213	284	427	569	474	7	11	23	34	45	68	91	136	181	227	272
PA6.6	3	80	0.68	85	142	213	284	427	569	474	7	11	23	34	45	68	91	136	181	227	272
PA6.6GF35	3	80	0.85	103	172	259	345	517	690	575	9	14	28	43	57	85	113	170	227	283	340
PBT	3.5	120	0.81	105	174	262	349	523	698	581	7	12	23	35	46	69	93	139	185	231	276
PC	3	120	0.72	134	224	336	448	672	896	746	7	12	24	36	48	72	96	144	192	240	288
PEEK	4	160	0.79	71	118	177	236	354	472	394	6	10	20	30	40	59	79	110	158	198	236
PE filled	3	90	0.57	81	135	202	269	404	538	448	6	9	19	29	38	57	76	114	152	190	228
PEI	3.5	150	0.76	129	214	321	429	643	857	714	7	11	22	33	43	65	87	130	174	217	260
PE	1.5	90	0.56	81	135	202	269	404	538	448	11	18	37	56	75	112	149	224	299	373	448
PES	3.5	150	0.82	118	197	296	395	592	789	658	7	12	23	35	47	70	94	141	187	234	280
PET	4	125	0.84	105	174	262	349	523	698	581	6	11	21	32	42	63	84	126	168	210	252
PET-A	6	170	0.84	85	141	211	282	423	563	469	4	7	14	21	28	42	56	64	112	140	168
PETG	4	65	0.76	103	172	259	345	517	690	575	6	10	19	29	38	57	76	114	152	190	228
PMMA	3.5	80	0.71	98	164	246	328	492	656	546	6	10	20	30	41	61	81	122	162	203	244
POM	2.5	100	0.85	108	181	271	361	542	722	602	10	17	34	51	68	102	136	204	272	340	408
PP	1.5	90	0.54	90	150	225	300	450	600	500	11	18	36	54	72	108	144	216	288	360	432
PPO	2.5	100	0.64	112	186	280	373	559	745	621	8	13	26	38	51	77	102	154	205	256	308
PPS	3.5	150	0.80	110	184	276	368	552	736	613	7	11	23	34	46	69	91	137	183	229	276
PS	1.5	80	0.63	111	185	278	370	556	741	617	13	21	42	63	84	126	168	252	336	420	504
PSU	2.5	140	0.74	71	118	176	235	353	470	392	9	15	30	44	59	89	118	178	237	296	356
PUR	2.5	90	0.73	90	150	225	300	450	600	500	9	15	29	44	58	88	117	175	234	292	352
PVC	1.5	70	0.81	157	261	391	522	783	1,043	870	16	27	54	81	108	162	216	324	432	540	648
SAN	2.5	80	0.65	121	201	302	403	604	805	671	8	13	26	39	52	78	104	156	208	260	312
SB	1.5	70	0.63	102	170	256	341	511	682	568	13	20	42	63	84	126	168	252	336	420	504
TPE-E	3	100	0.71	88	147	221	294	441	588	490	7	12	24	36	47	71	95	142	189	237	284
TPE-U	2	90	0.73	96	160	239	319	479	638	532	11	18	37	55	73	110	146	219	292	365	440



The modular design of the WITTMANN M8 hardware and software components and the arbitrary configuration enable the flexible realization of various special applications, like the equal load and automatic switchover between vacuum pumps, the controlled assignment of material sources to machines.



The use of high-quality installation material guarantees long life and trouble-free operation. The conveying of abrasive materials is accomplished preferably with glass elbows. The high performance Net5 system and M8 network controls are designed for highest durability. An important part of a highly reliable system is the professional and proper assembly of conveying tubes and connections. This includes the professional mounting of conveying tubes and connections.

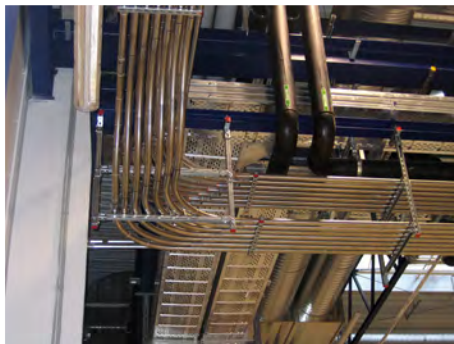

"No two central material handling systems are equal." – As varied as production facilities, so are the requirements on the central material handling system. Innovative product solutions are required more than ever before and can be achieved through the highly efficient WITTMANN controls.



"One-stop shopping." The extensive and innovative peripheral equipment program from WITTMANN allows the realization of demanding complete systems and the assignment of responsibility for the proper interaction of the single components. For service, a single phone call will cover the entire spectrum of WITTMANN products.

The Wittmann logo is a stylized, italicized wordmark in a dark red color, set against a white background that is part of a red parallelogram shape.

WITTMANN Technology GmbH

Lichtblaustrasse 10

1220 Vienna | Austria

Tel.: +43 1 250 39-0

info.at@wittmann-group.com

www.wittmann-group.com